

All information is subject to change without notice. Please read bottom notes.**FEATURES**

- (1) 15.0 type XGA display size for monitor
- (2) 8bit(6bit+FRC) Data Signal with 1ch-LVDS interface system
- (3) Wide Viewing Angle (Upper+Lower (140°)/ Left+Right (160°))
- (4) 16.19M Colors Display

TENTATIVE**MECHANICAL SPECIFICATIONS**

Item	Specifications
Dimensional Outline (typ.)	331.6(W) x 254.7(H) x 13.5max(D) mm
Number of Pixels	1024(W) x 768(H) pixels
Active Area	304.128(W) x 228.096(H) mm
Pixel Pitch	0.297(W) x 0.297(H)
Weight (approximately)	1210g
Backlight	4 CCFL, Sidelight type

ABSOLUTE MAXIMUM RATINGS

Item	Min.	Max.	Unit	
Supply Voltage	(V _{DD})	-0.3	4.0	V
	(V _{FL})	0	2.7	kV(rms)
FL Driving Frequency (f _{FL})	-	100	kHz	
Input Signal Voltage (V _{IN})	-0.3	V _{DD} +0.3	V	
Operating Temperature	0	50	°C	
Storage Temperature	-20	60	°C	
Storage Humidity	10	90	%(RH)	

ELECTRICAL SPECIFICATION (RECOMMENDED OPERATION CONDITION)

Item	Min.	Typ.	Max.	Unit	Remarks	
Supply Voltage	(V _{DD})	3.0	3.3	3.6	V	
	(V _{FL})	---	650	---	V(rms)	I _{FL} =6.0mA(rms)
FL Start Voltage (T _a =0°C)	1500	---	2000	V(rms)		
Differential Input Voltage(V _{ID}) ^{*1}	100	---	600	mV		
Common Mode Input Voltage(V _{CM}) ^{*1}	1.0	---	2.4 - 1/2 x V _{ID}	V		
Current Consumption	(I _{DD}) ^{*2}	---	380	---	mA	
	(I _{FL}) ^{*3}	3.0	---	6.5	mA(rms)	
*2 *3 Power Consumption (Target)	---	16.9	---	W	I _{FL} =6.0mA(rms)	

*1 : Refer to THC63LVDM83A/F84A Specification by Thine Electronics, Inc.

*2 : 8 color bars pattern

*3 : Excepting the efficiency FL inverter

OPTICAL SPECIFICATION (T_a=25°C)

Item	Min.	Typ.	Max.	Unit	Remarks
Luminance	---	350	---	cd/m ²	I _{FL} =6.0mA(rms)
Contrast Ratio (CR)	---	400	---	---	
Viewing Angle (CR>=10)	(Upper+Lower)	---	140	---	°
	(Left+Right)	---	160	---	°
Response Time	τ _r + τ _f	---	25	---	ms
Lamp Life Time (MTBF) ^{*4 *5}	50,000			h	

*4 : Conditions ; T_a=25°C, I_{FL}=6.0mA(rms), continuous lighting

*5 : Definitions of failure ; 1) Lcd luminance becomes half of the minimum value. 2) Lamp doesn't light normally.

*The information contained herein is presented only as a guide for the applications of our products. No responsibility is assumed by Toshiba Matsushita Display Technology or other rights of the third parties which may result from its use. No license is granted by implication or otherwise under any patent or patent rights of Toshiba Matsushita Display Technology or others.

*The information contained herein may be changed without prior notice. It is therefore advisable to contact Toshiba Matsushita Display Technology before proceeding with the design of equipment incorporating this product.

Unit: mm

Standard tolerance: 0.5

DIMENSIONAL OUTLINE(front figure)

TENTATIVE

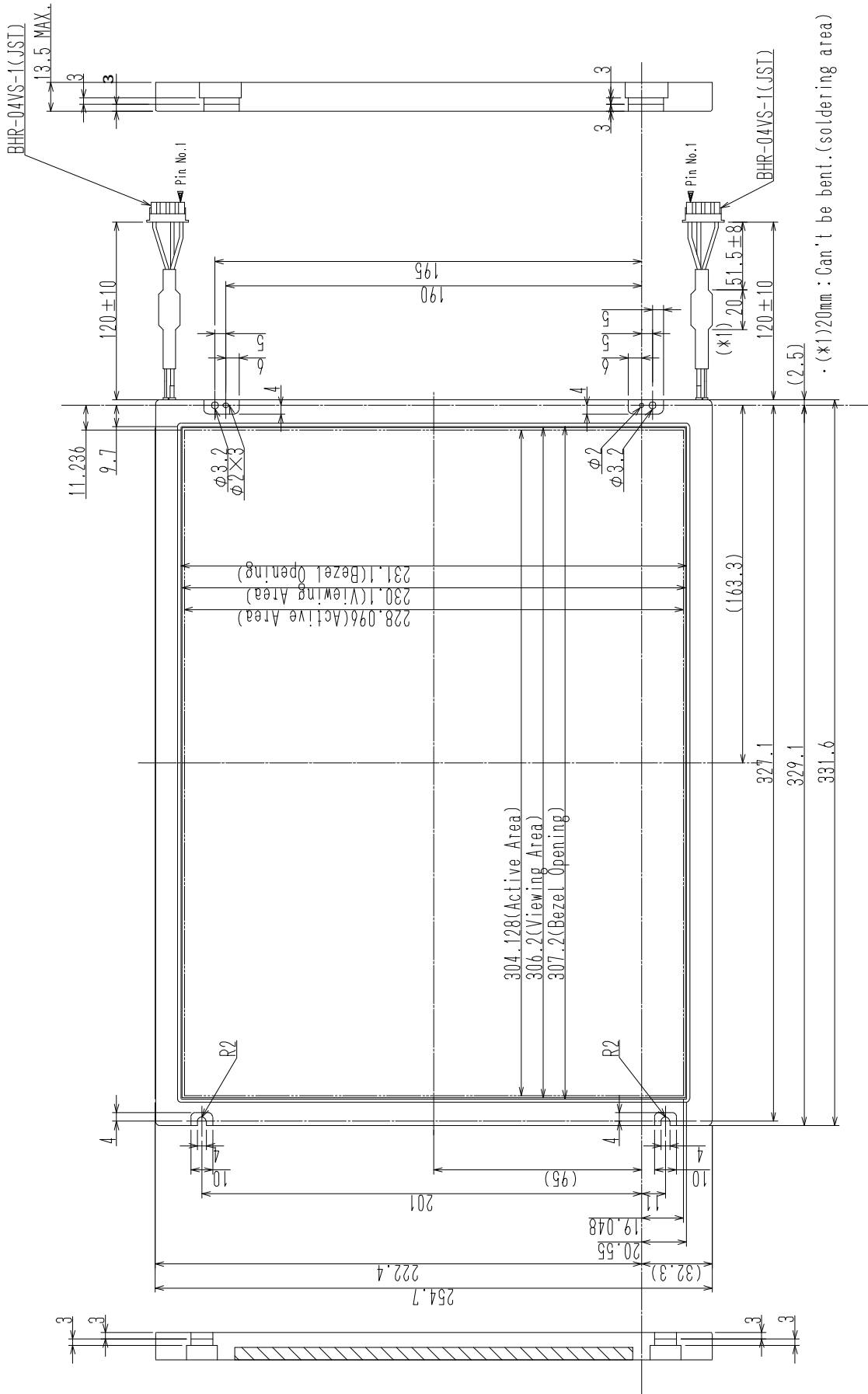

DIMENSIONAL OUTLINE(back figure)

TENTATIVE

Unit: mm

Standard tolerance: 0.5

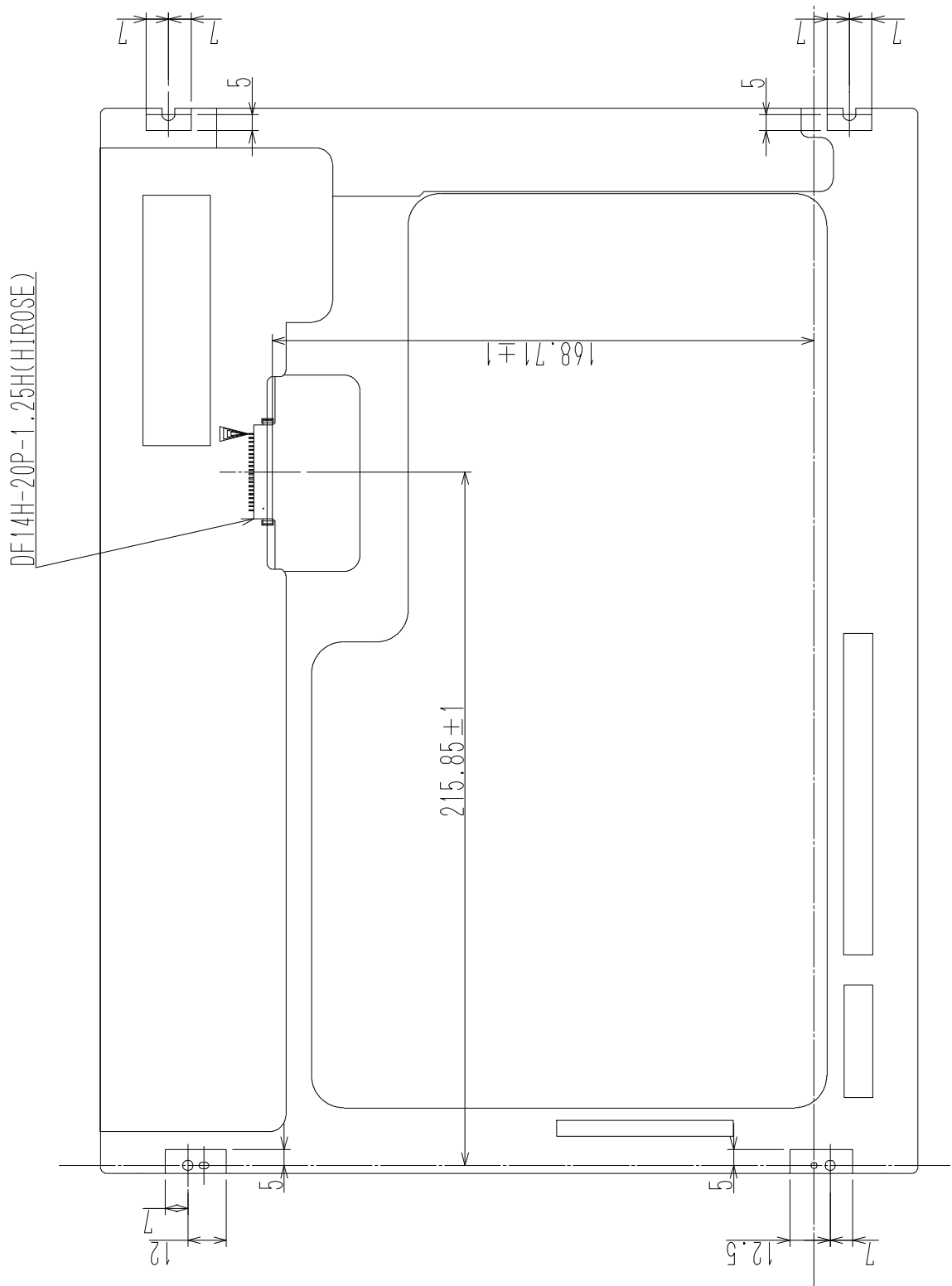

BLOCK DIAGRAM

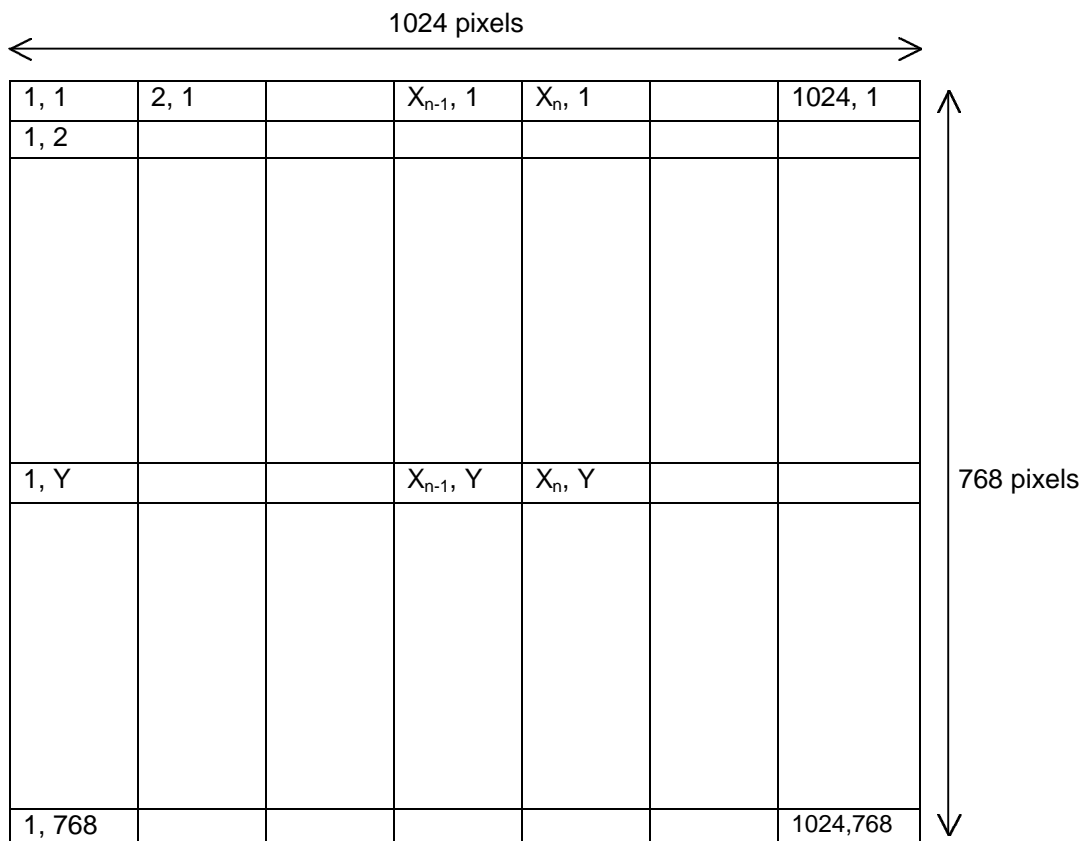
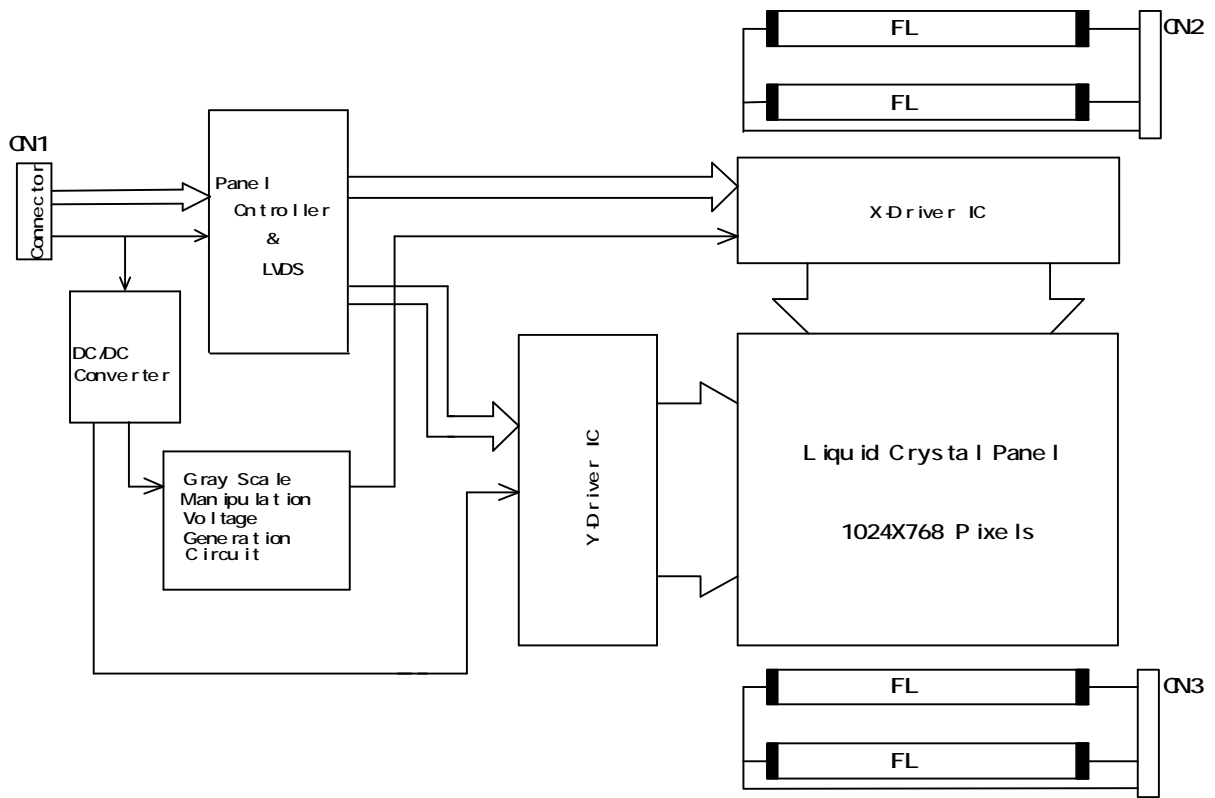

SEQUENCE OF POWER SUPPLIES AND SIGNALS

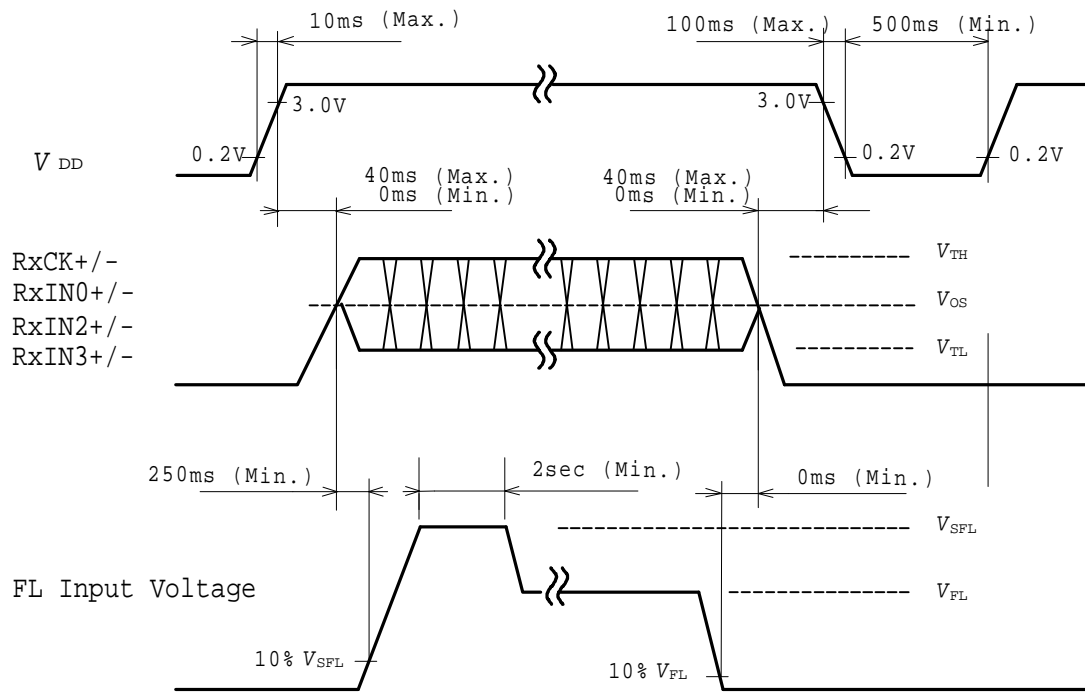

TIMING CHART

(1) Vertical Timing

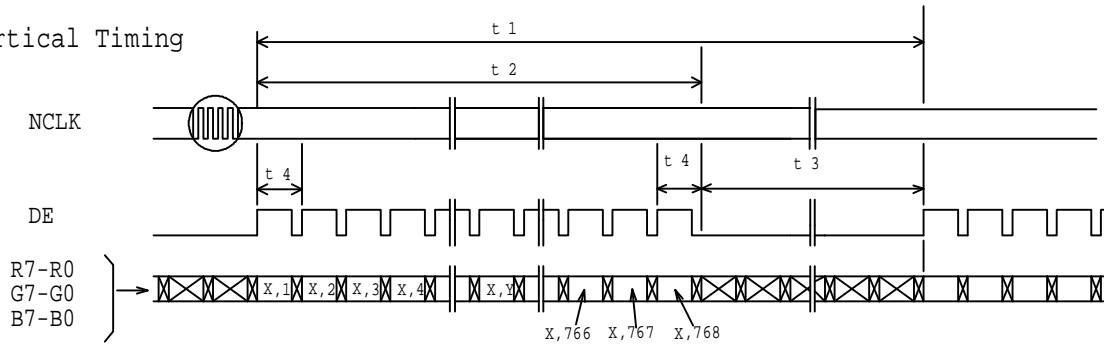

(2) Horizontal Timing

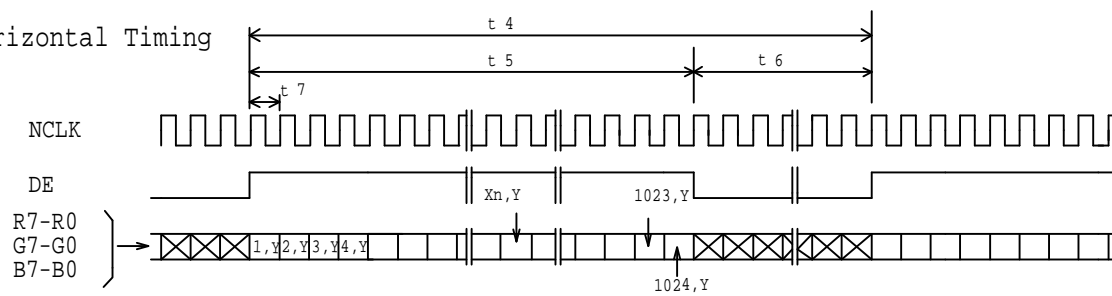

(3) Vertical / Horizontal Sync Timing

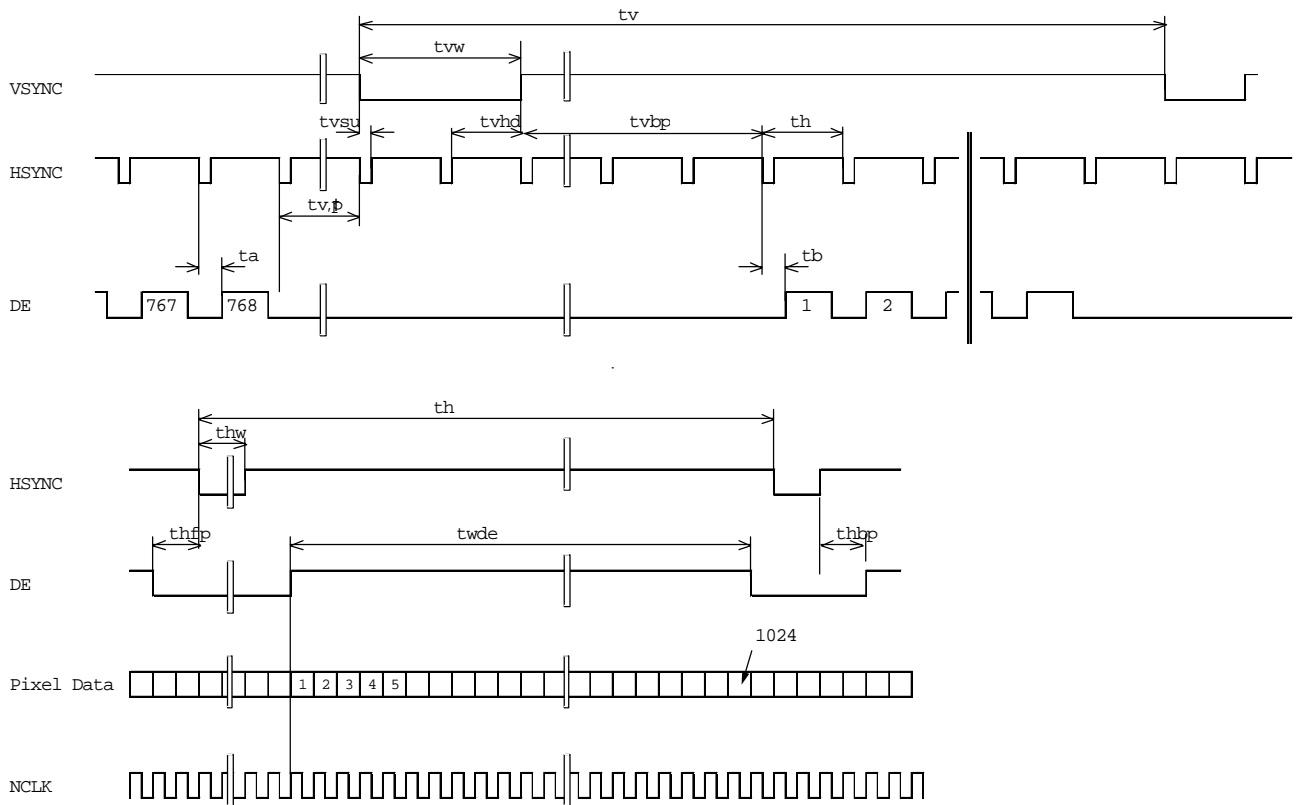

TIMING SPECIFICATION ^{1) 2) 3) 4)}

Item	Symbol	min.	typ.	max.	unit
Frame Period	t_1	790 x t4	-	950 x t4	-
		14.28	16.66	17.25	ms
Vertical Display Term	t_2	768 x t4	768 x t4	768 x t4	-
Vertical Blanking Term	t_3	22 x t4	-	182 x t4	-
1 Line Scanning Time	t_4	1090 x t4	-	1800 x t4	-
		15.80	-	28.34	us
Horizontal Display Term	t_5	1024 x t7	1024 x t7	1024 x t7	-
Horizontal Blanking Term	t_6	66 x t7	-	776 x t7	-
Clock Period	t_7	12.500	-	15.748	ns
V-Sync Pulse Width	tvw	2 x t4	-	-	-
V-Sync Set Up Time	$tvsu$	8 x t7	-	-	-
V-Sync Hold Time	$tvhd$	thbp + 16 x t7	-	-	-
Vertical Front Porch	$tvfp$	2 x t4	-	-	-
Vertical Back Porch	$tvbp$	6 x t4	-	-	-
Horizontal Period	th	1090 x t7	-	1800 x t7	-
		15.80	-	28.34	us
H-Sync Pulse Width	thw	8 x t7	-	-	-
Horizontal Front Porch	$thfp$	4 x t7	-	500 x t7	-
Horizontal Back Porch	$thbp$	8 x t7	-	492 x t7	-
$thw + thbp$		16 x t7	-	500 x t7	-
DE Pulse Width	$twde$	1024 x t7	1024 x t7	1024 x t7	-

$$t_3 = tvfp + tvw + tvbp$$

$$t_4 = th$$

$$t_6 = thfp + thw + thbp$$

$$tvds = tvw + tvbp$$

Note 1) Refer to "Timing Chart" and LVDS (THC63LVDF84A) specifications by THine Electronics, Inc..

Note 2) If ENAB is fixed to "H" or "L" level for certain period while NCLK is supplied, the panel displays black with some flicker.

Note 3) If NCLK is fixed to "H" or "L" level for certain period while ENAB is supplied, the panel may be damaged.

Note 4) Please adjust LCD operating signal timing and FL driving frequency, to optimize the display quality.

There is a possibility that flicker is observed by the interference of LCD operating signal timing and FL driving condition (especially driving frequency), even if the condition satisfies above timing specifications.

Note5) Do not make t_1 , t_2 , t_3 and $tvds$ fluctuate.

If t_1 , t_2 , t_3 and $tvds$ are fluctuate, the panel displays black.

Note6) In case of using the long frame period, the deterioration of display quality, noise etc. may be occurred.

Note7) NCLK count of each Horizontal Scanning Time should be always the same.

V-Blanking period should be " n " X "Horizontal Scanning Time". (n : integer)

Frame period should be always the same.

CONNECTOR PIN ASSIGNMENT FOR INTERFACE

CN1 INPUT SIGNAL

Connector: DF14H-20P-1.25H / HIROSE

Mating Connector: DF14-20S-1.25C / HIROSE

Terminal No.	Symbol	Function
1	V _{DD}	Power Supply: +3.3V
2	V _{DD}	Power Supply: +3.3V
3	GND	
4	GND	
5	RXIN0-	Transmission Data of Pixels 0 (Negative: -)
6	RXN0+	Transmission Data of Pixels 0 (Positive: +)
7	GND	
8	RXIN1-	Transmission Data of Pixels 1 (Negative: -)
9	RXIN1+	Transmission Data of Pixels 1 (Positive: +)
10	GND	
11	RXIN2-	Transmission Data of Pixels 2 (Negative: -)
12	RXIN2+	Transmission Data of Pixels 2 (Positive: +)
13	GND	
14	RXCK-	Sampling Clock (Negative: -)
15	RXCK+	Sampling Clock (Positive: +)
16	GND	
17	RXIN3-	Transmission Data of Pixels 3 (Negative: -)
18	RXIN3+	Transmission Data of Pixels 3 (Positive: +)
19	GND	
20	NC	

Note 1) NC terminal should be open.

CN2, 3 CCFL POWER SOURCE

Connector: BHR-04VS-1 / JAPAN SOLDERLESS TERMINAL MFG CO., LTD.

Mating Connector: SM03(7-D1)B-BHS-1 / JAPAN SOLDERLESS TERMINAL MFG CO., LTD.

Terminal No.	Symbol	Function
1	V _{FLH}	CCFL Power Supply (high voltage)
2	V _{FLH}	CCFL Power Supply (high voltage)
3		
4	V _{FLL}	CCFL Power Supply (low voltage)

RECOMMENDED TRANSMITTER TO LTM15C458T INTERFACE ASSIGNMENT

THC63LVDF83A,THC63LVDM83A,THC63LVDM83A-85 (by THine)				LTM15C458T Interface (CN1)		
Input Terminal No.		Input Signal (Graphics controller output signal)		Output Signal Symbol	Terminal	Symbol
Symbol	Terminal	Symbol	Function			
TA0	51	R0	Red Pixels Display Data (LSB)	TA- TA+	No.5 No.6	RxIN0- RxIN0+
TA1	52	R1	Red Pixels Display Data			
TA2	54	R2	Red Pixels Display Data			
TA3	55	R3	Red Pixels Display Data			
TA4	56	R4	Red Pixels Display Data			
TA5	3	R5	Red Pixels Display Data			
TA6	4	G0	Green Pixels Display Data(LSB)	TB- TB+	No.8 No.9	RxIN1- RxIN1+
TB0	6	G1	Green Pixels Display Data			
TB1	7	G2	Green Pixels Display Data			
TB2	11	G3	Green Pixels Display Data			
TB3	12	G4	Green Pixels Display Data			
TB4	14	G5	Green Pixels Display Data			
TB5	15	B0	Blue Pixels Display Data (LSB)	TC- TC+	No.11 No.12	RxIN2- RxIN2+
TB6	19	B1	Blue Pixels Display Data			
TC0	20	B2	Blue Pixels Display Data			
TC1	22	B3	Blue Pixels Display Data			
TC2	23	B4	Blue Pixels Display Data			
TC3	24	B5	Blue Pixels Display Data			
TC4	27	HSYNC	Horizontal Synchronization Signal	TD- TD+	No.17 No.18	RxIN3- RxIN3+
TC5	28	VSYNC	Vertical Synchronization Signal			
TC6	30	DE	Compound Synchronization Signal			
TD0	50	R6	Red Pixels Display Data			
TD1	2	R7	Red Pixels Display Data (MSB)			
TD2	8	G6	Green Pixels Display Data			
TD3	10	G7	Green Pixels Display Data(MSB)	TCLK- TCLK+	No.14 No.15	CLK- CLK+
TD4	16	B6	Blue Pixels Display Data			
TD5	18	B7	Blue Pixels Display Data (MSB)			
TD6	25	RES	1)			
CLK IN	31	CLK	Data Sampling Clock			

Note 1) It is highly recommended to connect this terminal with GND line.

LCD controller is NC (non connection.)

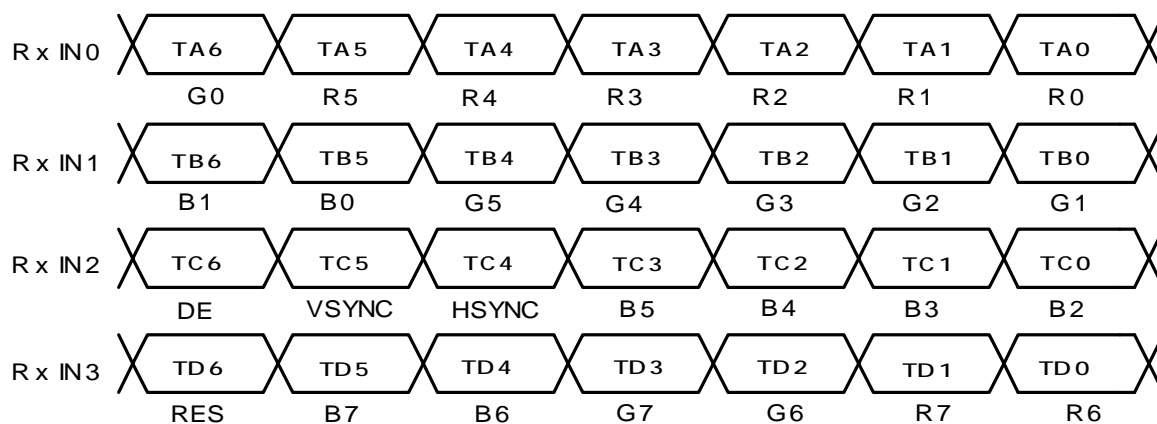

COLORS COMBINATION TABLE

	Display	R7 R6 R5 R4 R3 R2 R1 R0	G7 G6 G5 G4 G3 G2 G1 G0	B7 B6 B5 B4 B3 B2 B1 B0	Gray Scale Level
Basic Color	Black	L L L L L L L L	L L L L L L L L	L L L L L L L L	L 0
	Blue	L L L L L L L L	L L L L L L L L	H H H H H H H H	-
	Green	L L L L L L L L	H H H H H H H H	L L L L L L L L	-
	Light Blue	L L L L L L L L	H H H H H H H H	H H H H H H H H	-
	Red	H H H H H H H H	L L L L L L L L	L L L L L L L L	-
	Purple	H H H H H H H H	L L L L L L L L	H H H H H H H H	-
	Yellow	H H H H H H H H	H H H H H H H H	L L L L L L L L	-
	White	H H H H H H H H	H H H H H H H H	H H H H H H H H	L255
Gray Scale of Red	Black	L L L L L L L L	L L L L L L L L	L L L L L L L L	L 0
	Dark ↑ ↓ Light	L L L L L L L H	L L L L L L L L	L L L L L L L L	L 0
		L L L L L L H L	L L L L L L L L	L L L L L L L L	L 0
		L L L L L L H H	L L L L L L L L	L L L L L L L L	L 0
		L L L L L H L L	L L L L L L L L	L L L L L L L L	L 4
		:	:	:	L5... L252
		:	:	:	
		H H H H H H L H	L L L L L L L L	L L L L L L L L	L253
	H H H H H H H L	L L L L L L L L	L L L L L L L L	L254	
Red	H H H H H H H H	L L L L L L L L	L L L L L L L L	Red L255	
Gray Scale of Green	Black	L L L L L L L L	L L L L L L L L	L L L L L L L L	L 0
	Dark ↑ ↓ Light	L L L L L L L L	L L L L L L L H	L L L L L L L L	L 0
		L L L L L L L L	L L L L L L L H	L L L L L L L L	L 0
		L L L L L L L L	L L L L L L H H	L L L L L L L L	L 0
		L L L L L L L L	L L L L L L H L	L L L L L L L L	L 4
		:	:	:	L5... L252
		:	:	:	
		L L L L L L L L	H H H H H H L H	L L L L L L L L	L253
	L L L L L L L L	H H H H H H H L	L L L L L L L L	L254	
Green	L L L L L L L L	H H H H H H H H	L L L L L L L L	Green L255	
Gray Scale of Blue	Black	L L L L L L L L	L L L L L L L L	L L L L L L L L	L 0
	Dark ↑ ↓ Light	L L L L L L L L	L L L L L L L L	L L L L L L L H	L 0
		L L L L L L L L	L L L L L L L L	L L L L L L H L	L 0
		L L L L L L L L	L L L L L L L L	L L L L L L H H	L 0
		L L L L L L L L	L L L L L L L L	L L L L L H L L	L 4
		:	:	:	L5... L252
		:	:	:	
		L L L L L L L L	L L L L L L L L	H H H H H H L H	L243
	L L L L L L L L	L L L L L L L L	H H H H H H H L	L254	
Blue	L L L L L L L L	L L L L L L L L	H H H H H H H H	Blue L255	
Gray Scale of White & Black	Black	L L L L L L L L	L L L L L L L L	L L L L L L L L	L 0
	Dark ↑ ↓ Light	L L L L L L L H	L L L L L L L H	L L L L L L L H	L 0
		L L L L L L H L	L L L L L L H L	L L L L L L H L	L 0
		L L L L L L H H	L L L L L L H H	L L L L L L H H	L 0
		L L L L L H L L	L L L L L H L L	L L L L L H L L	L 4
		:	:	:	L5... L252
		:	:	:	
		H H H H H H L H	H H H H H H L H	H H H H H H L H	L253
	H H H H H H H L	H H H H H H H L	H H H H H H H L	L254	
White	H H H H H H H H	H H H H H H H H	H H H H H H H H	White L255	

RELIABILITY TEST

TEST CONDITIONS

- 1) The module should be driven and inspected under normal test conditions.
- 2) The module should not have condensation of water (moisture) on the module.
- 3) The module should be inspected after two or more hours storage in normal conditions (15 - 35°C, 45 - 65%(RH)).
- 4) A module shall be used only for one test.

SPECIFICATIONS

The module shall have no failure in the following reliability test items.

Test Item	Test Conditions	Result
High Temperature Operation ¹⁾	50°C 192 h	OK 3p/3p
High Temperature Storage ²⁾	60°C 192 h	OK 3p/3p
High Temperature High Humidity operation ¹⁾	50°C 80% 192 h	OK 3p/3p
Low Temperature Operation ¹⁾	0°C 192 h	OK 3p/3p
Low Temperature Storage ²⁾	-20°C 192 h	OK 3p/3p
Temperature Shock ²⁾	-20°C ↔ 60°C 0.5h 0.5h 50 cycles	OK 3p/3p
Mechanical Vibration ²⁾	10 - 200 - 10Hz sweep/cycle, 1.5×9.8m/s ² constant, X.Y.Z each directions, 0.5h each	OK 3p/3p
Mechanical Shock ²⁾	50×9.8m/s ² , 20ms, ±X, ±Y, ±Z direction, one time each	OK 3p/3p

Note 1) Operating

Note 2) Non-Operating

Definitions of failure for judgment shall be as follows:

- 1) Function of the module should be maintained.
- 2) Current consumption should be smaller than the specified value.
- 3) Appearance and display quality should not have distinguished degradation.
- 4) Luminance should be larger than 50% of the minimum value specified in OPTICAL SPECIFICATION.

**FOR SAFETY**

LCD module is generally designed with precise parts to achieve light weighted thin mechanical dimensions. In using our Modules, make certain that you fully understand and put into practice the warnings and safety precautions detailed in Engineering Information No.EE-N001,"CAUTIONS AND INSTRUCTIONS FOR TOSHIBA LCD MODULES". Refer to individual specifications and TECHNICAL DATA sheets (hereinafter called "TD") for more detailed technical information.

1) SPECIAL PURPOSES

A) Toshiba Matsushita Display Technology's Standard LCD Modules have not been customized for operation in extreme environments or for use in applications where performance failures could be life-threatening or otherwise catastrophic.

B) Since Toshiba Matsushita Display Technology's Standard LCD Modules have not been designed for operation in extreme environments, they must never be used in devices that will be exposed to abnormally high levels of vibration or shock which exceed Toshiba Matsushita Display Technology's published specification limits.

C) In addition, since Toshiba Matsushita Display Technology's Standard LCD Modules have not been designed for use in applications where performance failures could be life-threatening or catastrophic, they must never be installed in aircraft navigation control systems (such as, but not limited to Traffic Collision Avoidance System and Air Traffic Indicator), in military defense or weapons systems, in critical industrial process-control systems (e.g., those involved in the production of nuclear energy), or in critical medical device or patient life-support systems.

2) DISASSEMBLING OR MODIFICATION

DO NOT DISASSEMBLE OR MODIFY the module. It may damage sensitive parts inside LCD module, and may cause scratches or dust on the display.

Toshiba Matsushita Display Technology does not warrant the module, if customer disassembled or modified it.

3) BREAKAGE OF LCD PANEL

DO NOT INGEST liquid crystal material, DO NOT INHALE this material, and DO NOT CONTACT the material with skin, if LCD panel is broken and liquid crystal material spills out.

If liquid crystal material comes into mouth or eyes, rinse mouth or eyes out with water immediately.

If this material contact with skin or cloths, wash it off immediately with alcohol and rinse thoroughly with water.

4) GLASS OF LCD PANEL

BE CAREFUL WITH CHIPS OF GLASS that may cause injuring fingers or skin, when the glass is broken.

5) ELECTRIC SHOCK

DISCONNECT POWER SUPPLY before handling LCD module.

DO NOT TOUCH the parts inside LCD module and the fluorescent lamp's connector or cables in order to prevent electric shock, because high voltage is supplied to these parts from the inverter unit while power supply is turned on.

6) ABSOLUTE MAXIMUM RATINGS AND POWER PROTECTION CIRCUIT

DO NOT EXCEED the absolute maximum rating values under the worst probable conditions caused by the supply voltage variation, input voltage variation, variation in parts' constants, environmental temperature, etc., otherwise LCD module may be damaged.

Employ protection circuit for power supply, whenever the specification or TD specifies it.

Suitable protection circuit should be applied for each system design.

7) RECOMMENDED OPERATION CONDITIONS

The performance and quality of the LCD panel are warranted only when the LCD panel is used within "the recommended operation conditions". Toshiba Matsushita Display Technology Co., Ltd. never warrants the performance and quality of the LCD panel when you use the LCD panel over "the recommended operation conditions", although within "the absolute maximum rating".

To use the LCD panel over "the recommended operation conditions" may have bad influence on the characteristics and reliability of the LCD panel and may shorten the life of the LCD panel.

Therefore, when designing the whole set, not to be over "the recommended operation conditions", you should fully take care of supply voltage change, characteristic of connection parts, surge of input-and-output line, and surrounding temperature.

8) DISPOSAL

When dispose LCD module, obey to the applicable environmental regulations.